

# BMB

# SPEAKER SYSTEM CSV-900(SE)

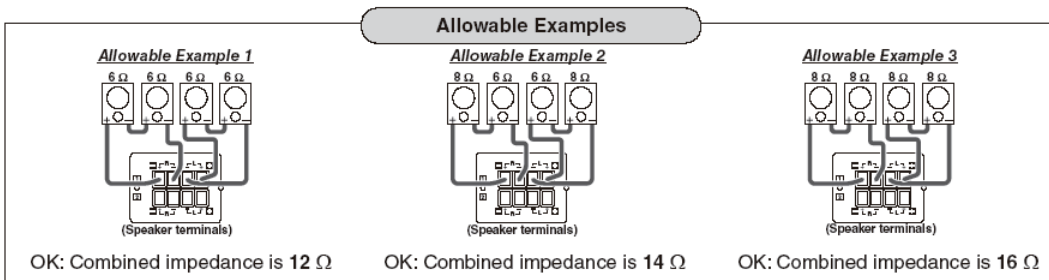
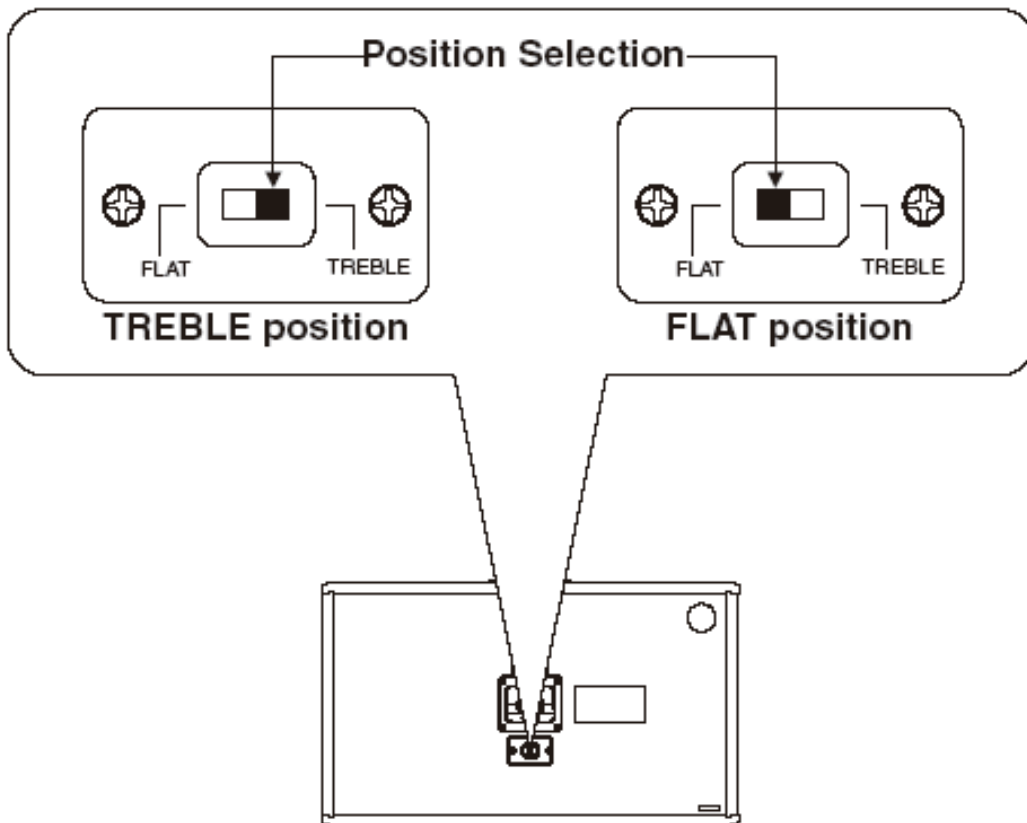
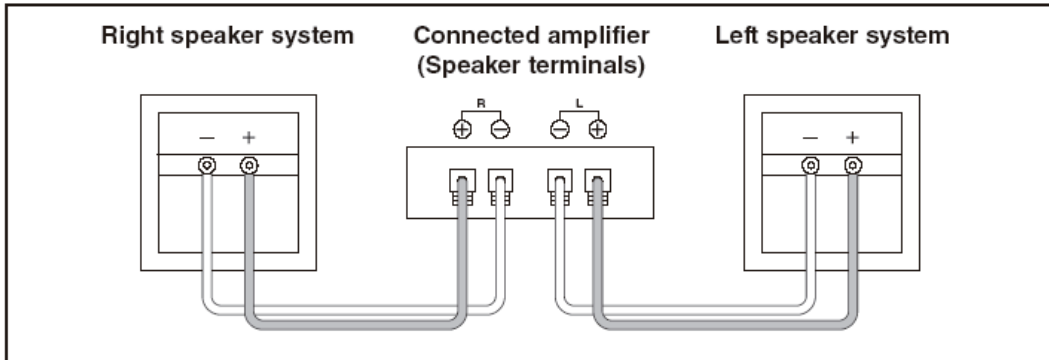

Not-allowable Examples

Not-allowable Example 1

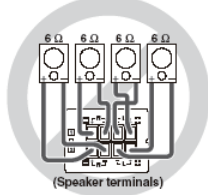

NG: Combined impedance is 3 Ω

Not-allowable Example 2

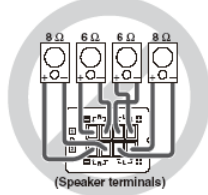

NG: Combined impedance is 3.4 Ω

Not-allowable Example 3

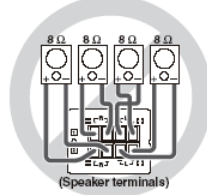

NG: Combined impedance is 4 Ω

TREBLE Position (Straight ahead from the tweeter)

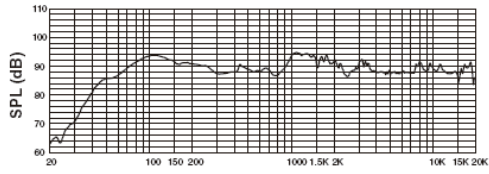

FLAT Position (Straight ahead from the tweeter)

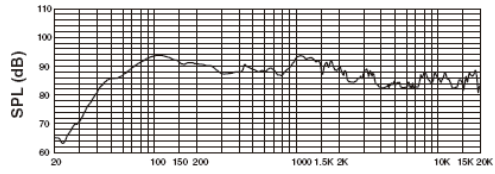

TREBLE Position

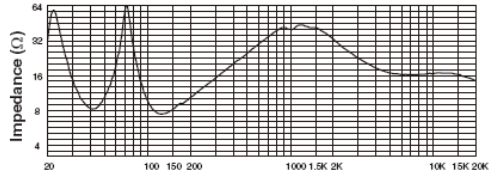

FLAT Position

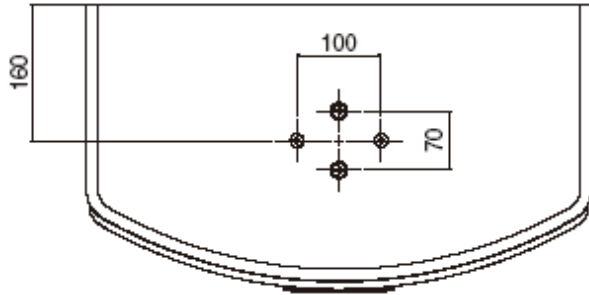
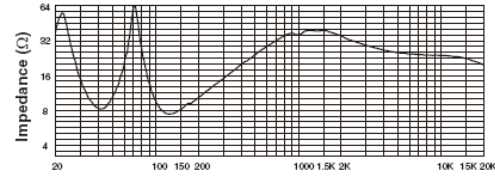

(mm)

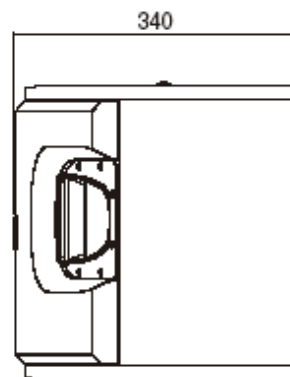
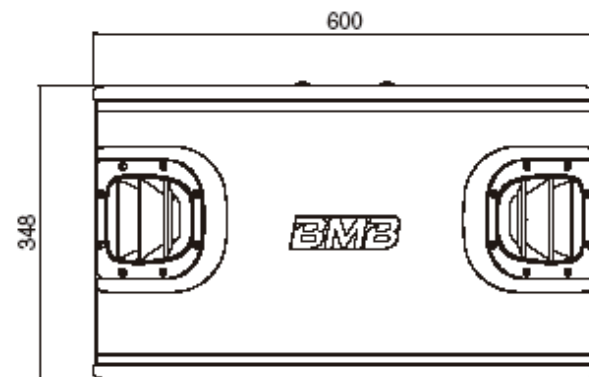

# OWNER'S MANUAL

THANK YOU VERY MUCH FOR PURCHASING THIS BMB SPEAKERS SYSTEM. BEFORE USE, PLEASE READ FOLLOWING INSTRUCTIONS THROUGH CAREFULLY AND FAMILIARIZE YOURSELF WITH THE OPERATION OF THE SYSTEM.

## BEFORE USE

### Operating Precautions

- The maximum input power of these speakers is 1200 W (at peak). Higher levels of input power may cause damage to the speaker system and so take every precaution to keep the power down to the specification.
- Even if an amplifier with a maximum output power of less than 1200 W is employed, do not use the speakers with the volume turned up too high or the sound distorted. This may damage the speakers.
- Make sure that the amplifier's power switch is at the OFF position when connecting the speakers to the amplifier.
- Make sure that the amplifier's volume control is turned down to its lowest setting when the amplifier's power switch is set to the ON position.

## CONNECTIONS

- Make sure that you set the power switch on the amplifier to the OFF position when connecting the speakers to the amplifier.
- Align the (–) and (+) polarities of the speakers with the (–) and (+) polarities of the left (L) and right (R) channels of amplifier, and connect the speakers to the speaker terminals on the amplifier.
  - \* If the polarities of the left and right speakers are not aligned properly, the quality of the reproduced sound, the ambience and the feeling of direction will all be markedly impaired.
  - \* When making the connections, take every precaution to prevent the speaker cords' central cores from being shorted.

## INSTALLATION

### Installing the Speakers

- Avoid installing the speakers in a location exposed to direct sunlight and high levels of humidity. Avoid also locations in the vicinity of stoves and other sources of heat.
- With a speaker system, the sound which is heard varies greatly according to the installation location. Bear in mind the following points in order to derive the most enjoyment from music.
  - a) Install the speaker at the upper position than your ears level when you listen to the sound under normal listening conditions.
  - b) The best distance between the speakers is approx. 2 to 5 m.
  - c) The bass sounds fuller if the speakers are installed on a solid and stable stand of shelf, or if they are placed against a wall. The bass sound will lose its impact if objects which do not reflect the bass well enough are placed in front of the speakers.
- If you plan to hang your speakers from the ceiling, contact a professional installer.

### **Caution:**

If you want to suspend the CSV-900 from the ceiling, use adequate mounting hardware that can bear the load. In addition, be sure to secure the mounting hardware onto a place of high-tensile strength using screws appropriate to the ceiling materials.

## MAINTENANCE OF CABINET

When the cabinets are dirty, clean off the dirt with a soft cloth. If the dirt is engrained, moisten a soft cloth in cold or lukewarm water, wring it out, and then wipe off the dirt. Never use thinners or alcohol since these substances can impair the finish of the cabinet. Also, avoid using insecticide and other sprays near the speakers.

## tone CONTROL

- This speaker system offers a slide switch that gives you two tone choices: TREBLE and FLAT. The TREBLE position is intended for listening in a large room; the FLAT position is suitable for a small room. This switch is located on the rear face of each speaker.

## Making Allowable Connections between Speakers and Your Amplifier (Ex. 4 Speakers)

- Configure and wire the speakers so that the combined impedance falls within 6 to 32  $\Omega$ .

### **Note:**

The specification allows the combined impedance ranging 4 to 32  $\Omega$ , however, 4  $\Omega$  configuration is not recommended; avoid it whenever possible.

## ACCESSORIES

Owner's manual: 1 pc

## **SPECIFICATIONS**

Type:	2-WAY 3 SPEAKER BASS-REFLEX SYSTEM
Speaker units:	30 cm Cone Type Woofer x 1 8 cm Cone Type Tweeter x 2 (with multi-cellular horn)
Maximum input power:	1200 W
Rated input power:	500 W
Sound pressure level:	91 dB/W/m
Frequency response:	40 - 20 kHz
Impedance:	8 $\Omega$
Dimensions:	600 (W) x 348 (H) x 340 (D) mm
Mass:	17.5 kg

# **BMB International Corp.**

<http://www.bmb.com>