

Small format PA system for flexible applications such as permanent installations or at trade fairs.
6x M10 mounting points.

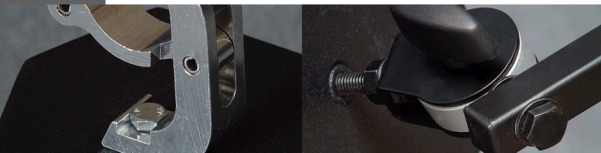

PRODUCT SPECIFICATIONS

Speaker Components	8" / 1"
Description	Multipurpose Sound System
Powerhandling - AES / Peak	150 Watt / 350 Watt
Impedance - nominal	16 Ohm
SPL 1m - 1Watt / Peak	95dB / 121dB
Usable Range	80Hz - 22kHz
Tuning Frequency - Excursion min.	85Hz
X - Overpoint - acoustical	2,0kHz
Connectors	2x Neutrik Speakon 4-pol Coding: 1+/- HiMid, 2+/- Sub
Coverage - horizontal / vertical	90° x 60°
Rigging - flying points	6 x M10
Weight	9,0kg
Size - height x width x depth	37,9 x 25,0 x 22,8 cm
Art. Nr.	0980

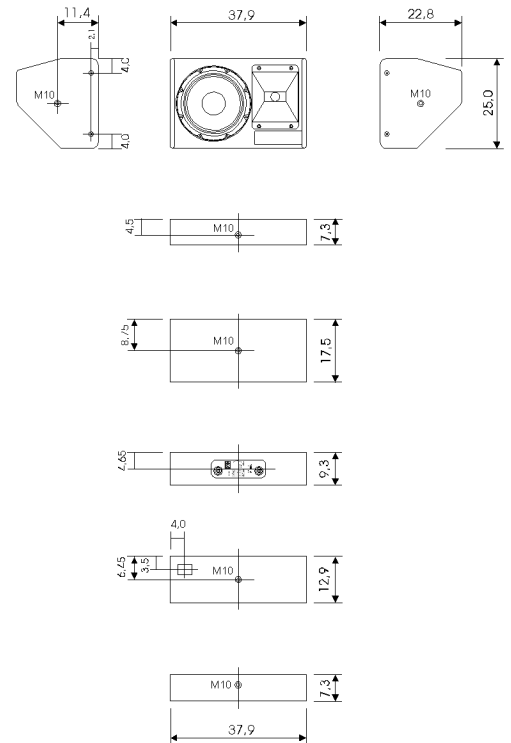

TSMini horizontal - 2D Directivity Plot

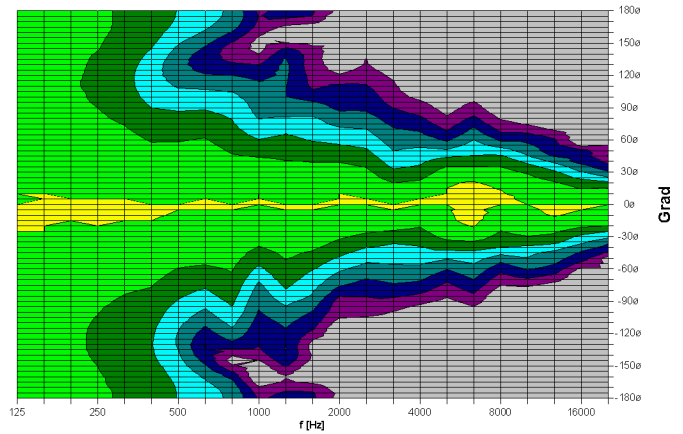

TSMini vertikal - 2D Directivity Plot

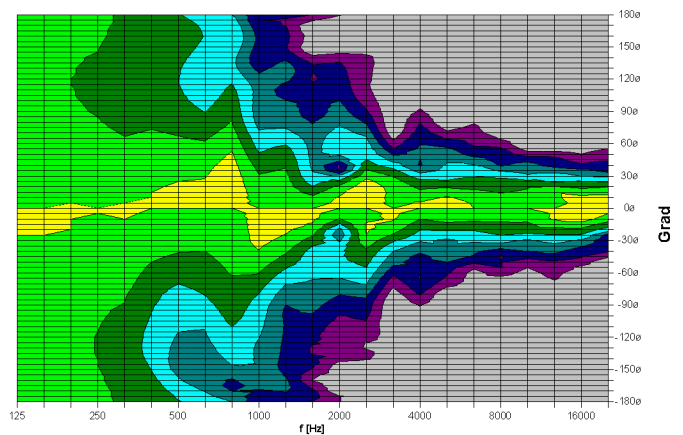

For more information, please visit our Data CD-Rom

Accessories (more accessories you can find in our general list of accessories)

Flying bracket for TSMini horizontal assembly incl. screws

(per unit: 2 pcs M10 x 20 socket head screws,
spring - and rubber washers.
- optional feature: 2 pcs M10 x 20 ergostyle lobe knob)

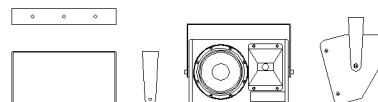

Order number: 01213 set

Flying Bracket for TSMini incl. screws

(per unit: 2 pcs. M10 x 20 ergostyle lobe knob
and rubber washers)

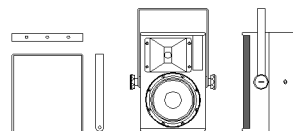

Order number: 01213 set

Flange M10 for TSMini

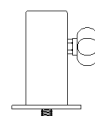

Order number: 08126

Bag for 2 pcs. TSMini



Order number: 01248

Flightcases
on request